

Ventilation Equipment
304 S/S Wall Hood+Filters
160X1200mm

ITEM # _____

MODEL # _____

NAME # _____

SIS # _____

AIA # _____



640189 (EPF1216)

304 stainless steel Wall
Hood with filters**Short Form Specification****Item No.** _____

Constructed in 304 AISI stainless steel. Continuously welded joints. Equipped with labyrinth filters (positioned on front) in 304 AISI stainless steel, blind panels in 304 AISI stainless steel, grease collecting trough all around and condensate drain sleeve. The rear baffle directs the fumes towards the filter surface, condensing the steam which is then conveyed through the outer ducting into the discharge. Suitable for use where large volumes of steam must be exhausted (i.e. ovens, dishwashers, pan washers, etc.)

Main Features

- External panels with upturned edges to avoid injuries.
- Prearranged for installation of lighting.
- Perimetral welded gutter with condensate drain (diam.= 3/8").
- Low noise level.

Construction

- Eyebolts and screw anchors for ceiling installation.
- Labyrinth filters guarantee constant filtration to avoid clogging and to protect against fire.
- 304 AISI stainless steel blind panels for a correct exhaustion.
- Outlet holes are sized in order to minimize drops in pressure.
- Internal baffle to facilitate steam condensation and collection.
- Entirely constructed in 304 AISI stainless steel.
- 304 AISI stainless steel labyrinth filters easily removable for cleaning.

APPROVAL: _____

Front

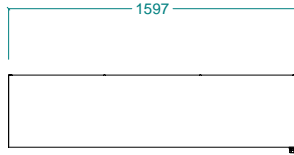

Top

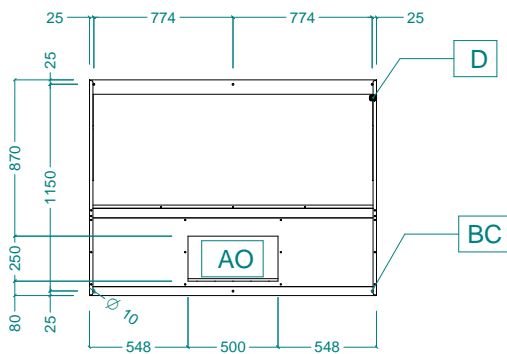

Side

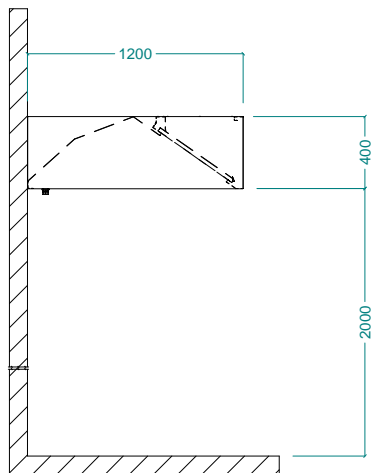
Key Information:

External dimensions, Width:	
640189 (EPF1216)	1600 mm
External dimensions, Depth:	1200 mm
External dimensions, Height:	400 mm
Net weight:	40 kg

Air Emission:

Air capacity:	2500 mc/h
---------------	-----------